

www.RAYA-WINDOWS.co.uk

THE RAYA PRODUCT RANGE

UPVC WINDOWS



VERTICAL SLIDING WINDOWS

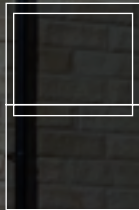

TILT & TURN WINDOWS

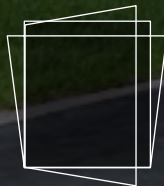
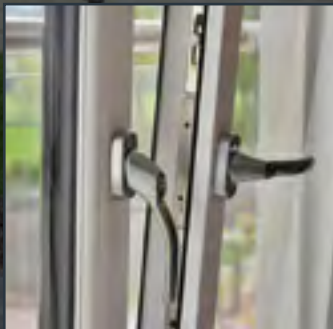

WHAT IS RAYA?	04
THE REASONS	06

WINDOWS

CASEMENTS WINDOWS	10
HERITAGE VERTICAL SLIDERS	14
TILT & TURN	18
SLIDING PATIO DOORS	22

COLOURS	24
HARDWARE	26

ICENI
RAYA

WHAT IS RAYA?

A brand conceived from the belief in ourself.

RAYA is the suite of window products we manufacture from Rehau profile. It's the same profile we have used for years, and the same system you are already installing.

Why the name?

Superior manufacturing elevates our product above all window products. When you need the best, RAYA is your premier thought.

The same products, transcending others by simply making them better.



THE REASONS

RAYA IS PERFECT FOR YOUR NEXT PROJECT

RAYA windows offer a range of stylish energy efficient window systems to compliment any home. All offer a high gloss finish, slim sight lines and the highest possible thermal and acoustic performance.

Our uPVC window systems include; casement windows, bay windows, windows that tilt and turn and heritage style sliding sash windows.

These styles no longer have to be just white, you can now choose colour and create a unique look for your home.

FEATURES & BENEFITS

ENHANCED SECURITY

RAYA windows and doors are tested to the highest security standards giving you an added level of security to your home and family.

The Secured by Design* police initiative endeavours to design-in security elements at an early stage of the production.

*Secured By Design is available upon specification.



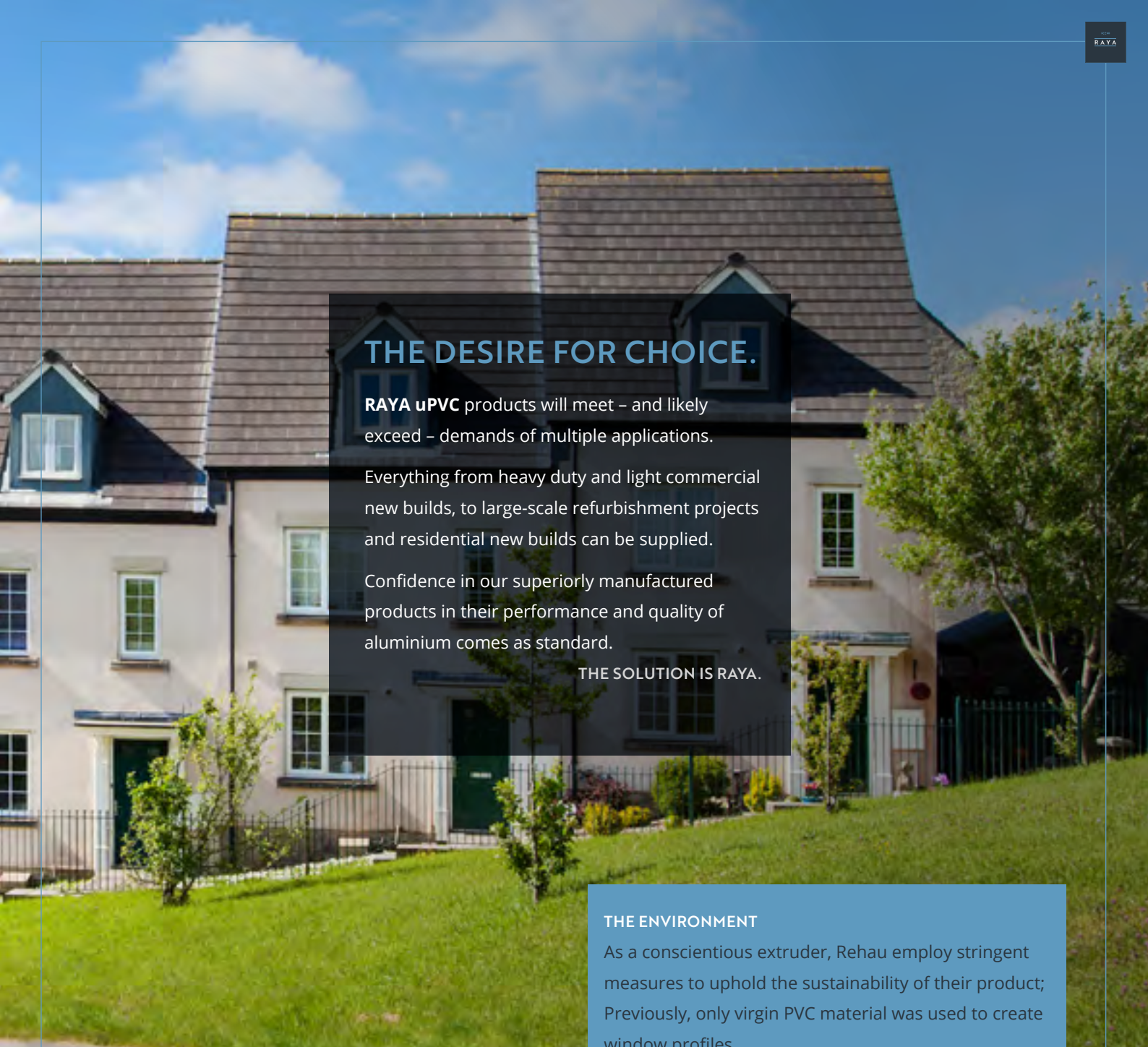

THE DESIRE FOR CHOICE.

RAYA uPVC products will meet – and likely exceed – demands of multiple applications.

Everything from heavy duty and light commercial new builds, to large-scale refurbishment projects and residential new builds can be supplied.

Confidence in our superiorly manufactured products in their performance and quality of aluminium comes as standard.

THE SOLUTION IS RAYA.

QUALITY AND PERFORMANCE

RAYA window systems have been tested in accordance with and meet the highest requirements of BS7412 for the standard of a manufactured window.

ENERGY EFFICIENT WINDOWS

All RAYA window systems can achieve a WER A rating - the highest energy rating, making your home more efficient and save money on your heating bills.

ACOUSTIC PERFORMANCE

Double glazing is well known for its ability to reduce outdoor noise levels and new windows manufactured from RAYA profile can help bring down the noise levels in your home by as much as a half.

THE ENVIRONMENT

As a conscientious extruder, Rehau employ stringent measures to uphold the sustainability of their product; Previously, only virgin PVC material was used to create window profiles.

Co-extrusion adds a second material and combines the best characteristics of both materials. Which keeps valuable raw materials in the process when recycled after the initial product life cycle.

WEATHER PERFORMANCE

Independently tested RAYA windows and doors achieve the highest ratings (PAS 24*) for wind, water and air; protecting your home from the elements.

*PAS 24 rated products are available upon specification.

LOW MAINTENANCE

RAYA windows contain a unique compound that guarantees a smooth, high gloss finish meaning that your new windows retain their pristine appearance for years to come.

ICENI
RAYA
UPVC WINDOWS

RAYA UPVC WINDOWS

RAYA WINDOWS

A BRAND TO MATCH THE HIGH STANDARD OF OUR MANUFACTURE

FEATURES

- 1 70mm deep window and door system
- 2 Multi-chamber profile
- 3 Integral gasket
- 4 Steel reinforcement – larger sized elements
- 5 3mm outer wall thickness
- 6 Easy glazing
- 7 Up to 44mm glazing
- 8 Choice of frame styles: sculptured or chamfered
- 9 Hardware fixed into steel
- 10 Central Euro-groove position

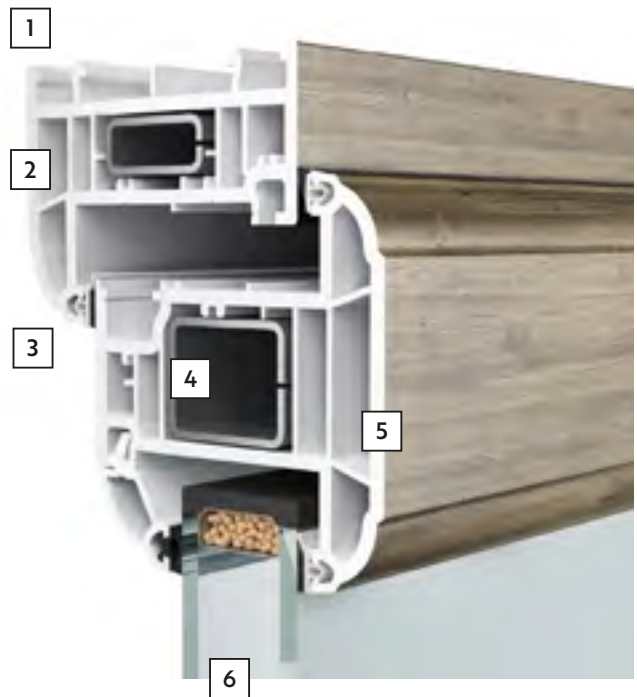

OPTIONS & BENEFITS

- Interchangeable profiles allow for multiple style combinations to be manufactured
- Fully sculptured detail for enhanced style to both modern and traditional properties
- Optional features include run through sash horn, clip-on Georgian bars and various glazing bead style options
- Various combinations of fixed and opening sections make this window extremely versatile
- Corrosion resistant Austenitic screws made from 302-grade Austenite stainless steel. Which is intrinsically soft making it perfect for use in our uPVC windows.
- Innovative methods of producing top-quality window profiles, enable different PVC materials to be processed on the core of the profile and the outer skin.

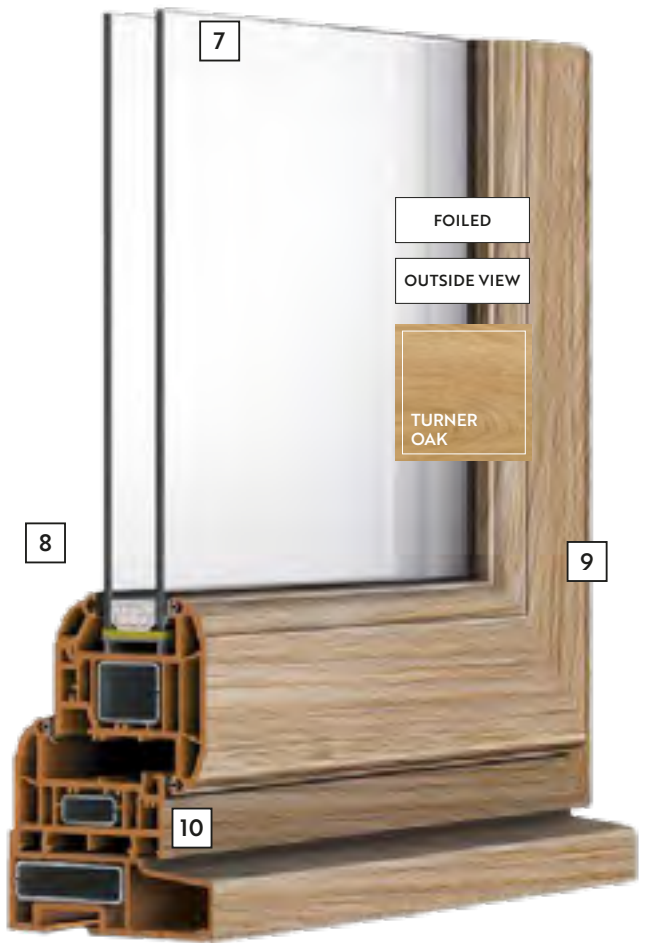

RAYA UPVC CASEMENT

The main choice for uPVC

CONFIGURATIONS

TOP HUNG

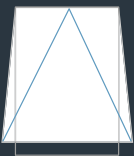

SIDE HUNG



FRENCH CASEMENT

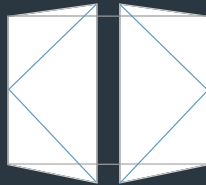

SIDE HUNG & FIXED LIGHTS

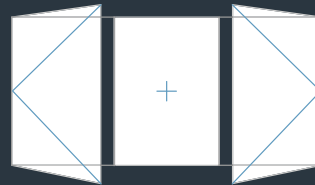

TILT & TURN

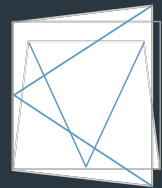

TOP HUNG & FIXED LIGHTS

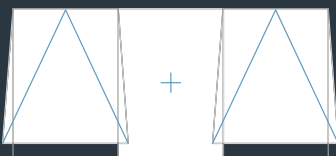

MULTI LIGHT & TOP HUNG

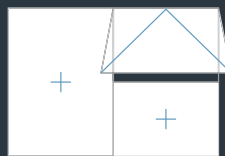

TOP HUNG & MULTI-LIGHTS

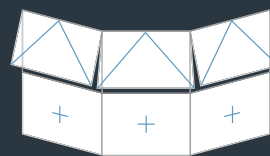

VERTICAL SLIDERS

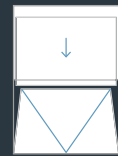

RAYA CASEMENT WINDOWS CAN BE COMBINED TO FORM
AN ALMOST LIMITLESS RANGE OF STYLES



STYLE: EDGE

REINFORCED



0.8
W/(M²K)
U-VALUE
TRIPLE GLAZED

STYLE: BEVEL

FEATURES & BENEFITS

- **Multi-chamber profiles:** The RAYA window range includes profiles with 5 chambers for improved thermal efficiency without compromising on structural capability.
- **Integral gasket:** RAYA windows are supplied with gaskets already integrated into the profile.
- **Ancillary profiles:** A large range of ancillary profiles including sills, weather rails, head drips, baypoles, couplers and frame extensions, are compatible across the entire RAYA windows range.
- **Easy glazing:** RAYA's single-leg glazing beads and retention detail guarantees on-site glazing is easy and secure when fitted.
- **Surface finish:** RAYA is renowned for its quality, demonstrated with a high gloss surface finish that provides a long-lasting appearance with little or no maintenance.
- **Larger reinforcement chamber:** To allow additional strength/rigidity when necessary, a larger reinforcement chamber enables a range of galvanised steels to be inserted for optimum performance.
- **Positive friction-stay location:** To reduce the strain on screws and hinges, positive friction-stay location is added for improved performance.
- **Hardware fixed into steel:** If required, the hardware used on RAYA windows profiles can be fixed into the steel reinforcement on both sash and frame. This allows for improved technical performance and superior security levels.

TECHNICAL AREA:

RAYA CASEMENT PROFILE



THIS IMAGE:
OUTSIDE VIEW
REINFORCED
ANTHRACITE GREY GRAINED

CHAMFERED PROFILE

(ALSO REFERRED TO AS BEVEL)

Our most popular window system.

This chamfered (bevelled) is simple yet elegant, helping to create contemporary frames.



THIS IMAGE:
OUTSIDE VIEW
150MM SILL
REINFORCED
ELEPHANT GREY

SCULPTURED PROFILE

(ALSO REFERRED TO AS EDGE)

A sympathetic replacement for timber carries style for both modern and traditional properties.

A decorative sculptured edge will maintain character of older properties.

SPECIFICATION	
Feature	Specification
Profile depth	70 mm
Maximum window size	1200 x 1200 mm (top hung) 900 x 1500 mm (side hung)
Maximum Thermal performance	0.8 W/m ² K
Max. sash weight	40kg
Glass width	28mm, 36mm or 44mm



RAYA CASEMENT WINDOW (CHAMFERED)

- 1 Larger reinforcement chambers allow for additional strength / rigidity when necessary
- 2 Optional features include a part sculptured T sash
- 3 Ideal replacement for British timber casement windows due to 70mm depth
- 4 28mm, 36mm or 44mm glazing options
- 5 Can achieve U-Values of 0.8 W/m²K using the triple glazed Argon sealed units.
- 6 Wide range of styles and combinations e.g. French, bay and bow windows
- 7 Complies with building regulations

TECHNICAL AREA: CASEMENT PROFILE DRAWINGS

CHAMFERED (BEVEL)

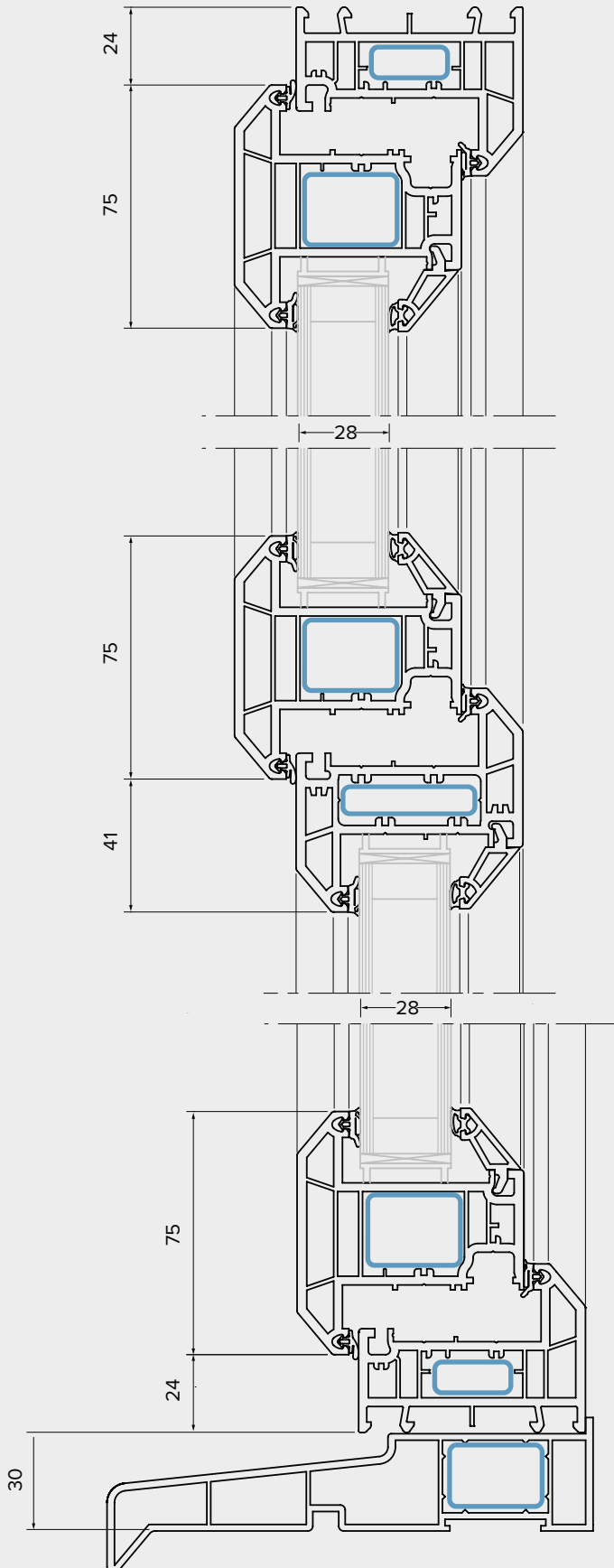

SCULPTURED (EDGE)

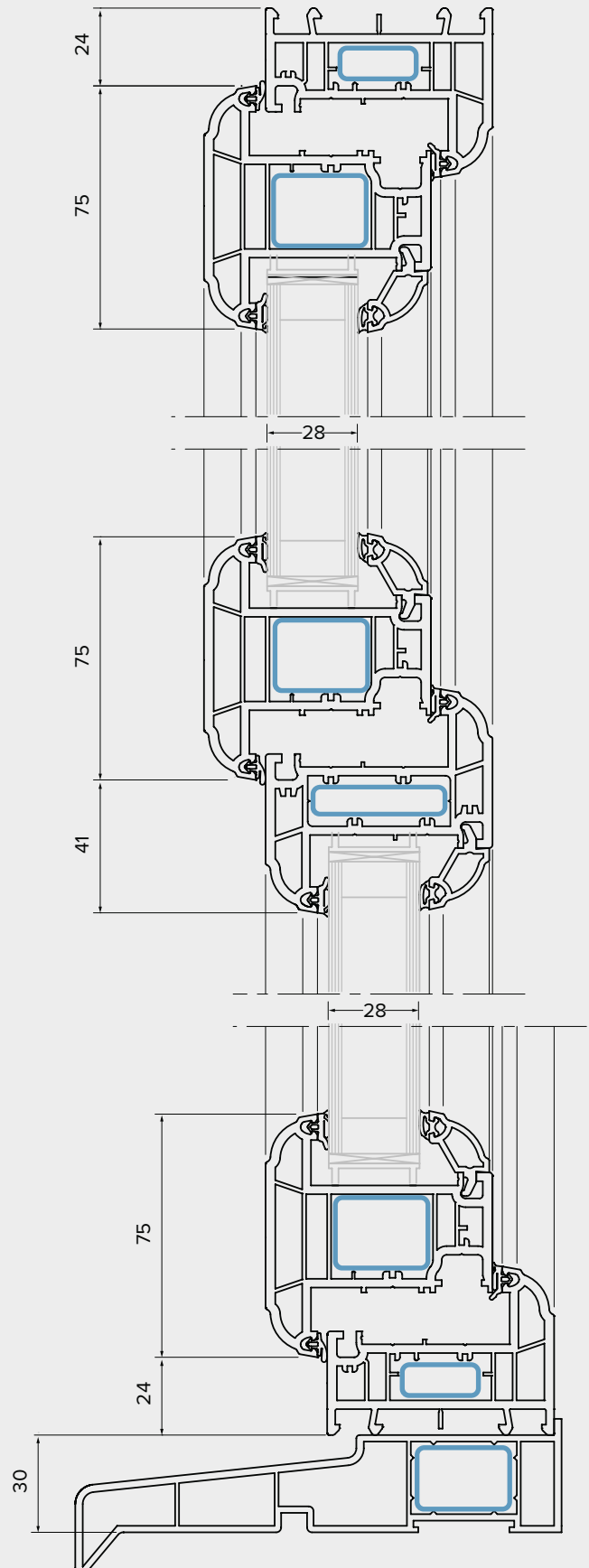



VERTICAL SLIDER

RAYA HERITAGE

Period style vertical sliding sash windows

CLASSIC CHARACTERISTICS

This vertical sliding window's deep bottom rail replicates aesthetics of traditional timber windows.

The core of this vertical sliding system has been developed following extensive consultation with conservation bodies and as a result, our sliding sash windows are the most distinctive and authentic-looking uPVC sash window available in the UK.

FEATURES

- Approved for use in UK conservation areas
- Optional Georgian bars
- Optional sash horns
- Traditional timber sash window aesthetics
- Perfect as energy-efficient replacement windows in character and period homes
- Suits Victorian, Georgian and Edwardian buildings
- Authentic period aesthetics make it perfect for use on new builds that need traditional styling





Superbly engineered and of exceptional quality, vertical sliding windows add genuine authenticity and style without sacrificing performance

ATTENTION TO DETAIL

Classic-style hardware and fittings and optional decorative horns replicate the traditional timber sash window to create a stunning finish.

Further attention to detail in the form of a deep bottom rail and optional Georgian bars add to a simply superior modern sash window.

TECHNICAL AREA:

VERTICAL SLIDING SASH

1.1
W/(m²K)
U-VALUE
TRIPLE GLAZED



RAYA VERTICAL SLIDING SASH WINDOW

- 1 28mm glazing
- 2 Georgian or astragal bars for an authentic appearance.
- 3 Triple brush seals in the frame create a barrier against wind and air
- 4 These windows can be fully welded or mechanical construction
- 5 Deep bottom rail profile as standard
- 6 Tilt function for cleaning (see p14)

SPECIFICATION	
Feature	Specification
Profile depth	137 mm
Maximum window size	1500 x 3000mm
Thermal performance	Exceeds 1.1 W/m2K
Max. sash weight	50kg
Glass width	28mm
Further options	Georgian bars Fixed or run through sash horns Sliding latches allowing for tilting

TECHNICAL AREA:

VERTICAL SLIDING SASH PROFILE DRAWING

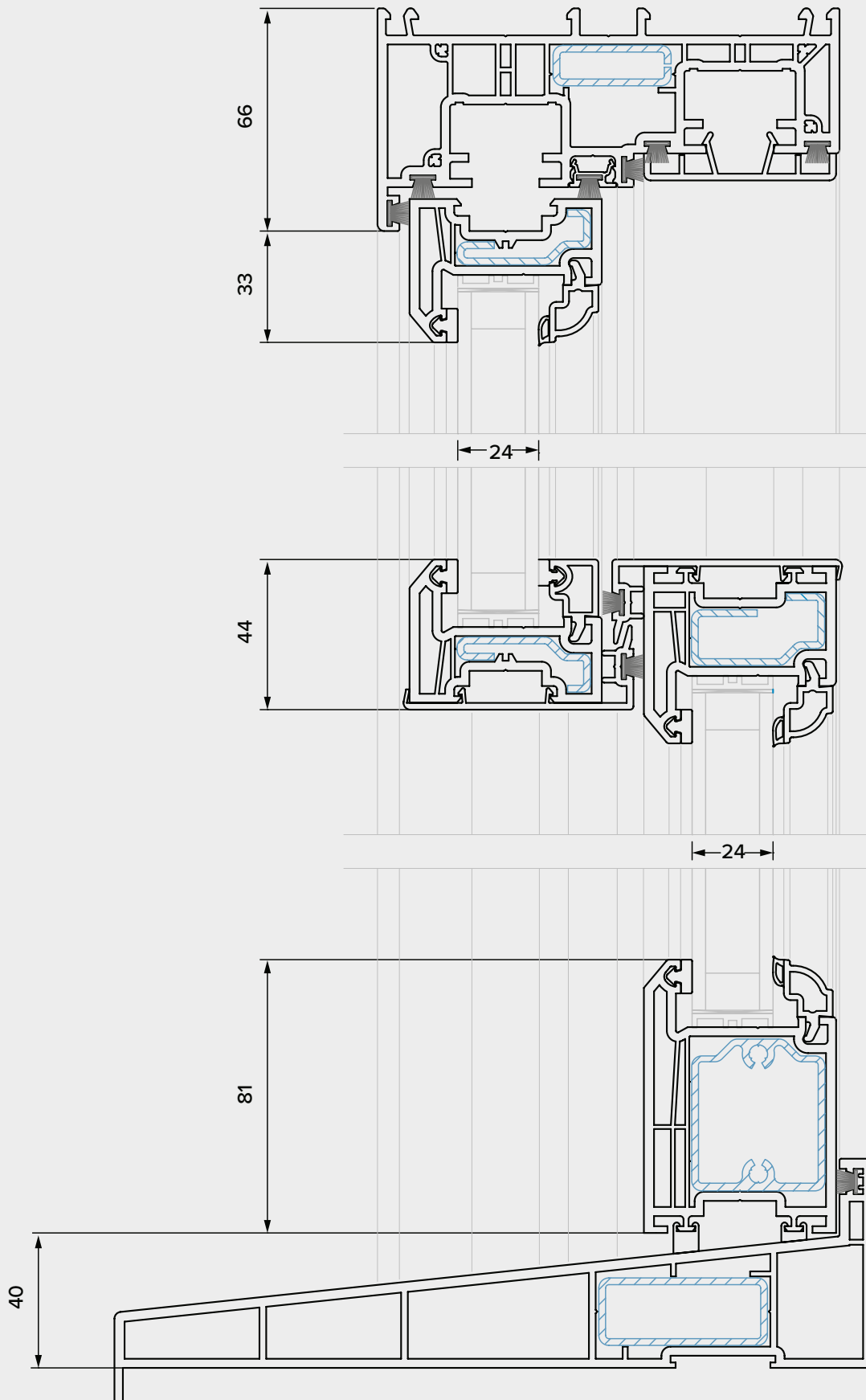

TILT & TURN WINDOWS

Contemporary style, versatile function

Tilt and Turn offers simplicity and versatility.

The ideal solution for restricted external space; this system allows you to tilt the top towards you, or open fully inward on side hung hinges.

This flexibility provides secure ventilation and ease of cleaning from within.

This system also provides an effective fire escape.

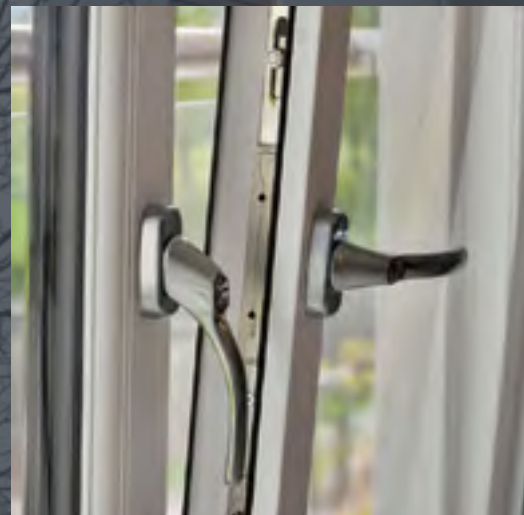

FEATURES

- Secure ventilation
- Easy cleaning
- Ideal for restricted space
- An effective fire escape
- Secure ventilation and ease of cleaning

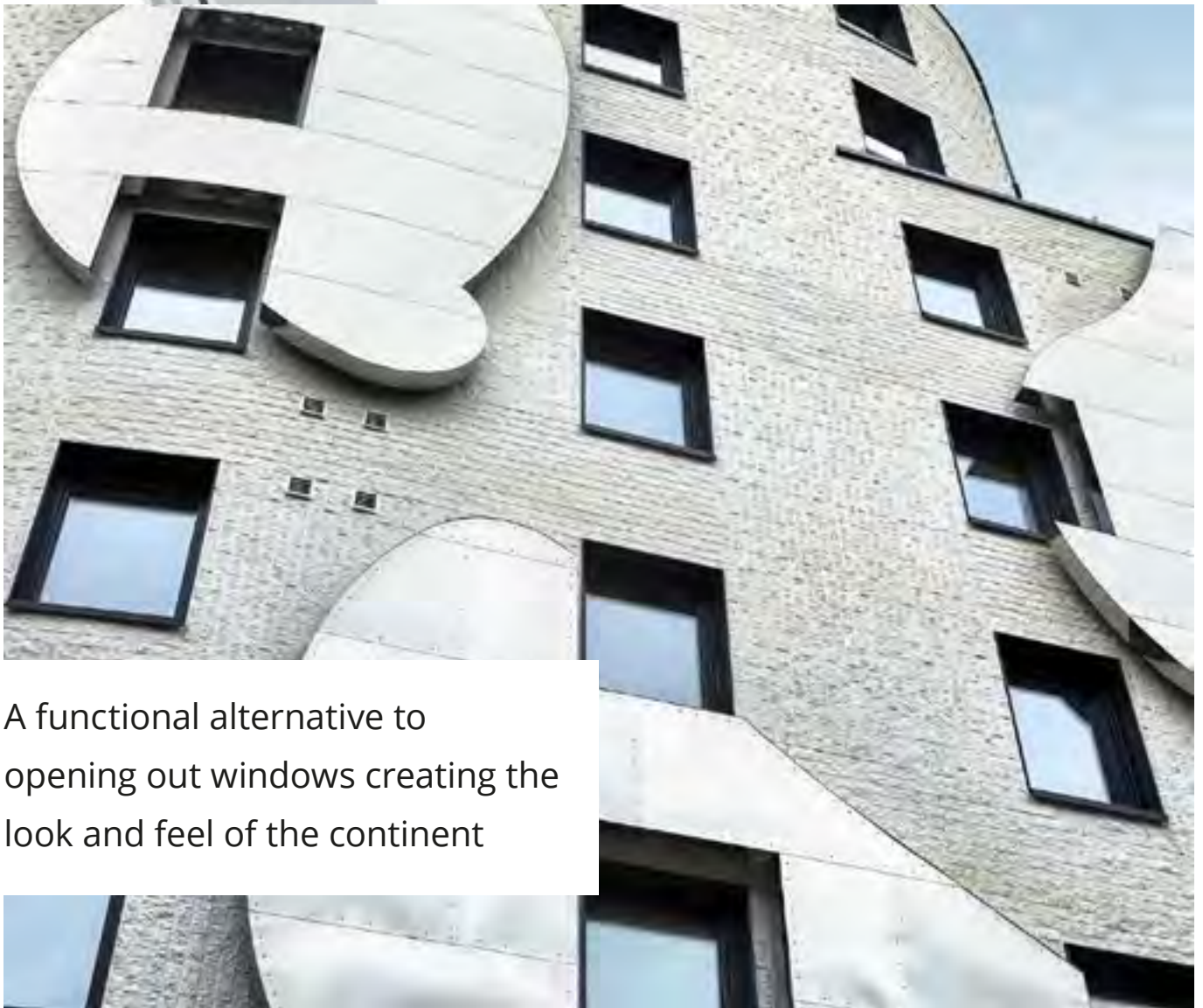

A functional alternative to opening out windows creating the look and feel of the continent

TECHNICAL AREA:

TILT & TURN CROSS SECTION & PROFILE DRAWING

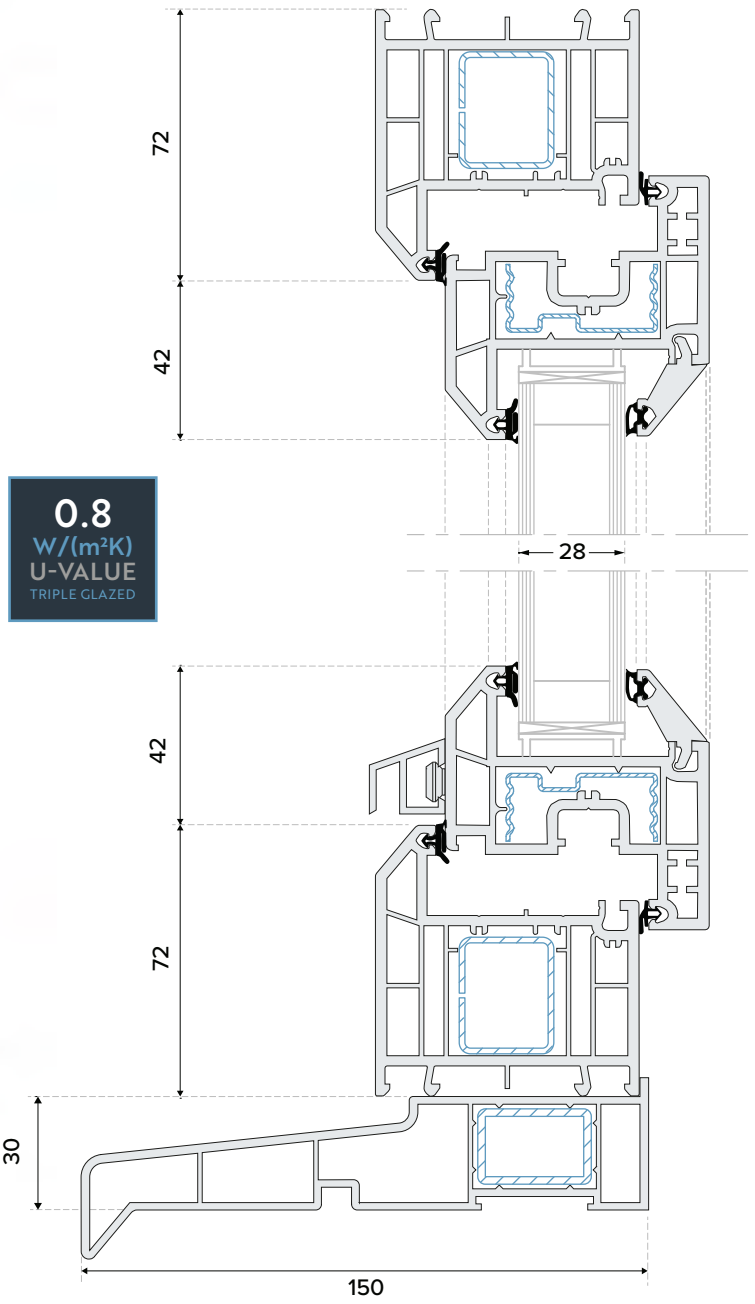
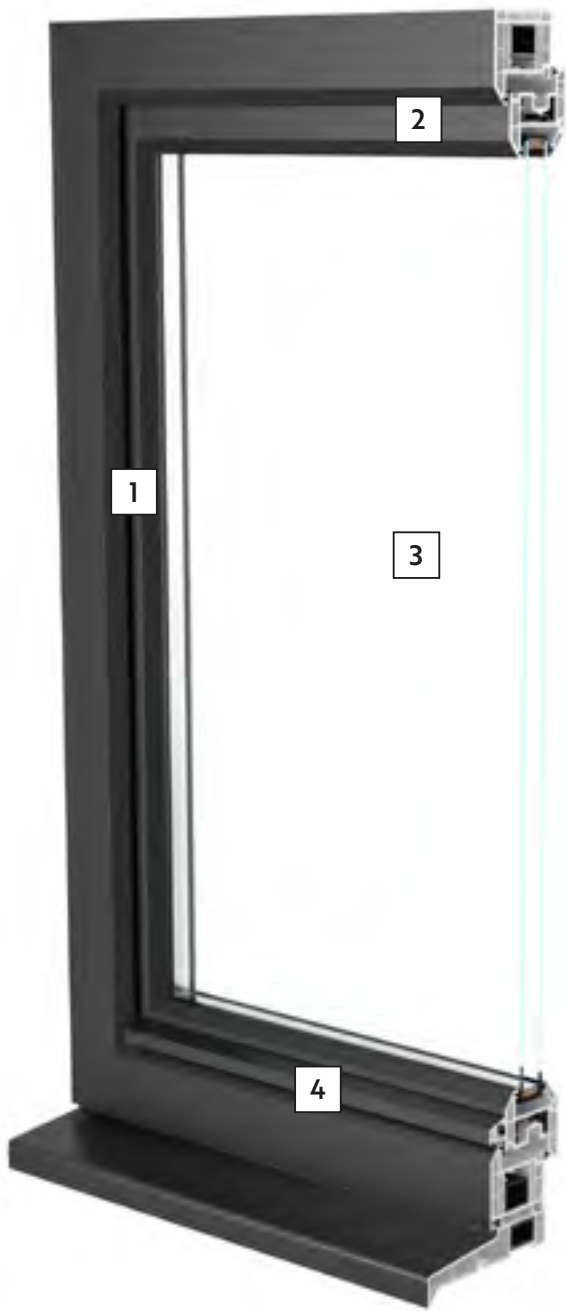

0.8
W/(m²K)
U-VALUE
TRIPLE GLAZED

TILT & TURN

RAYA TILT & TURN

- 1 16mm integrated Euro-groove allowing for hardware options
- 2 Can tilt for minor ventilation or turn and open to feel the full benefits
- 3 Inward opening for effective fire escape and where restricted outside space makes outward opening hazardous
- 4 Slimmer sight-lines for enhanced aesthetic appeal

SPECIFICATION	
Feature	Specification
Profile depth	70 mm
Maximum window size	1000 x 2200 mm (side hung)
Thermal performance	0.8 W/m ² K
Max. sash weight	100kg
Glass width	Up to 44mm

TECHNICAL AREA: RAYA EDGE/SCULPTURED SUITE

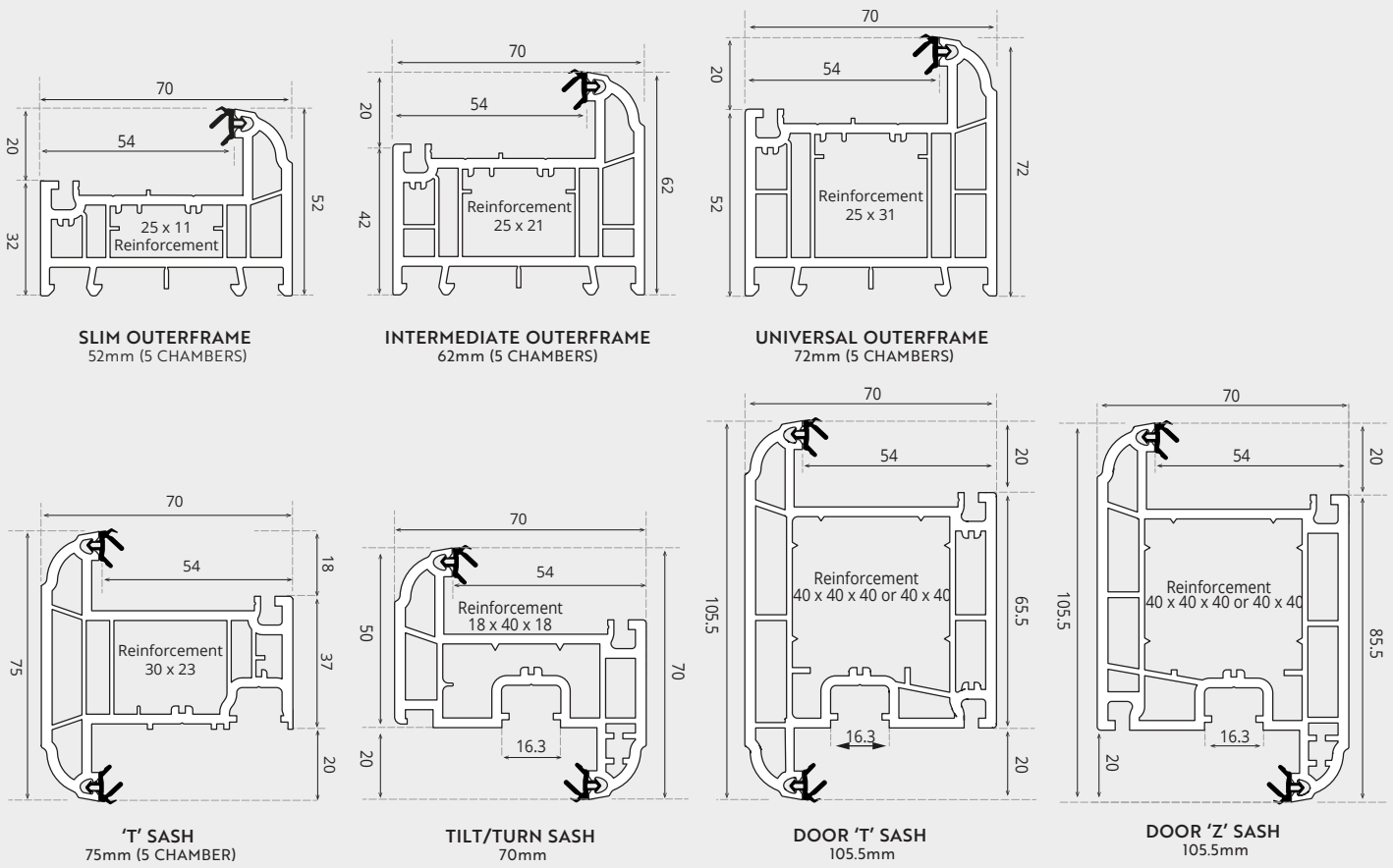

TECHNICAL DRAWINGS

RAYA CHAMFERED/BEVELLED SUITE

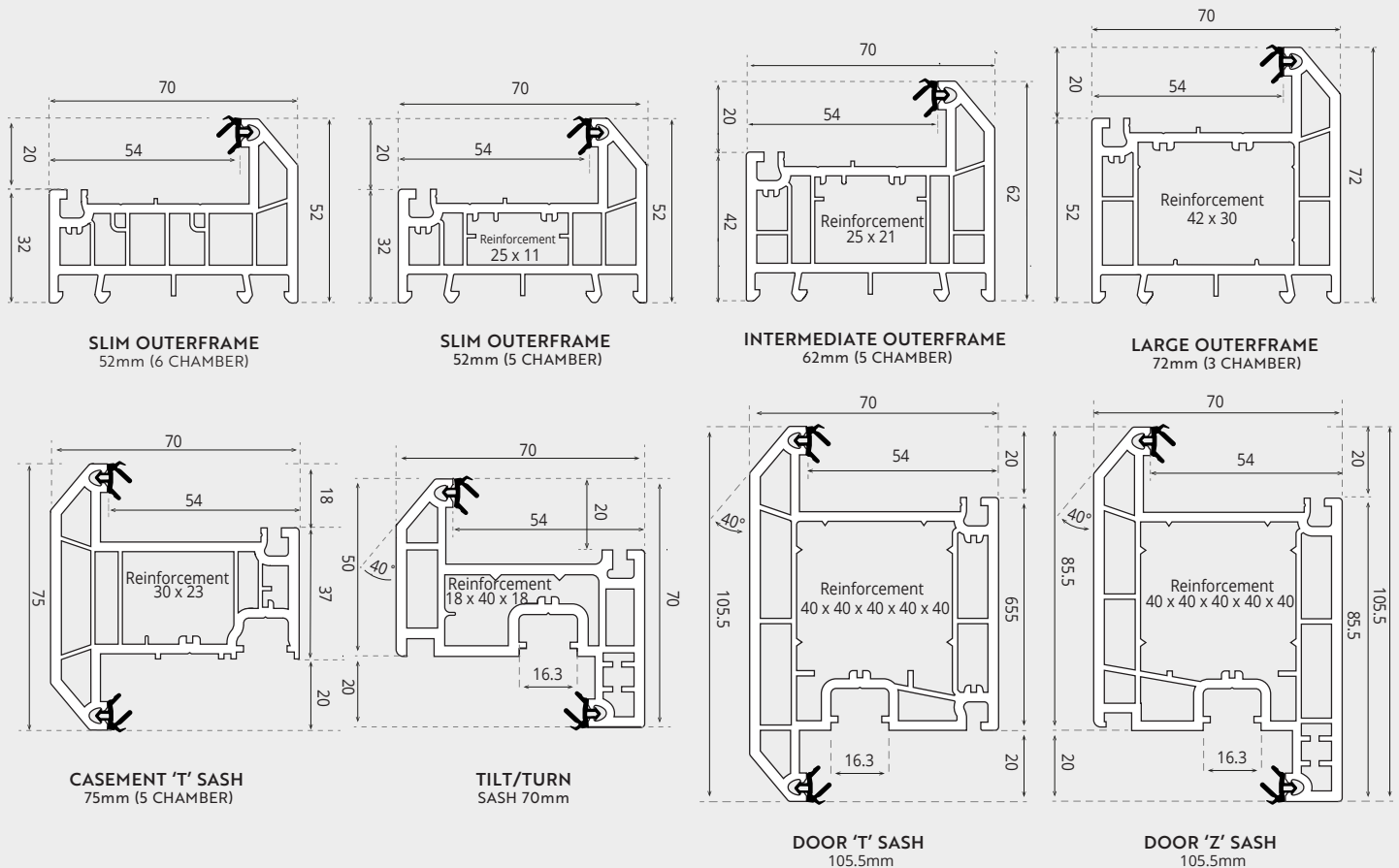

PLEASE NOTE: This is only a selection of the main profile drawings.

Please visit raya-windows.co.uk to view and/or download the complete technical profile data sheets.



RAYA SLIDING PATIO

Large glass surface for maximum natural light

Remarkable performance in a streamlined form, for modern and environmentally responsible housing.

FEATURES

- Welded frame
- Few or no reinforcements
- Pre-mounted seals on the sash
- Compatible with existing REHAU accessories (glazing beads, connector profiles) for lighter storage.

COLOURS

- 200 colours and finishes available and guaranteed for 5, 10 or 20 years (Kaleido Foil, paint and woodc)
- The possibility of different internal and external colours
- A fully veneered frame rebate.

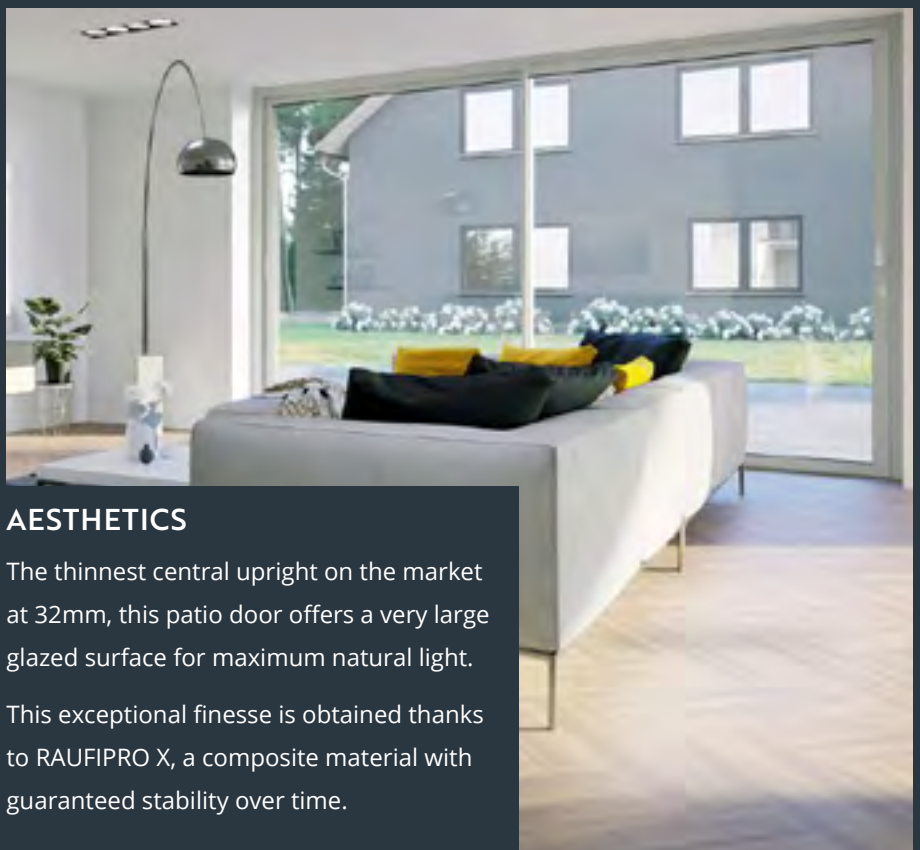

AESTHETICS

The thinnest central upright on the market at 32mm, this patio door offers a very large glazed surface for maximum natural light.

This exceptional finesse is obtained thanks to RAUFIPRO X, a composite material with guaranteed stability over time.

RAYA SLIDING PATIO DOOR

- Veneered frame rebate
- Thermal break in the frame rebate
- RAUFIPRO X profiles, containing a minimum of 40% recycled uPVC material
- 80mm threshold or wide 173mm threshold (2 and 3 rails)



CONFIGURATIONS



2 leaves



4 leaves

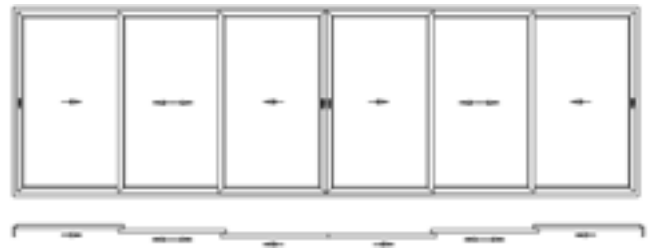

6 leaves

TECHNICAL SPECIFICATION	
Frame depth	Two rails 80 mm, Three rails 146 mm
Sash depth	54 mm
Visible profile	Width Frame + sash: from 121 mm to 144 mm
Assembly	Welded sash, welded frame or mechanically assembled
Material	REHAU EcoPuls PVC profile, with steel reinforcement according to the system manufacturer's specifications. Sash and frame with a minimum of 40% to 75% recycled PVC, Vinyl Plus certification
Seal material	The seal between the window frame and the sash is ensured by two circumferential brush seals. The glazing seal in the sash is welded in the corner area.
Maximum glass thickness	32 mm
Maximum sash weight	Up to 140 kg
Central jamb width	80 mm
Maximum dimensions (W max / H max)	4.9m x 2.7m
Heat transmission coefficient Uf	1.8 W/(m ² K)
Wind load	Resistance Up to class B2/C1 according to DIN EN 12210
Rain permeability	Up to class 7A according to DIN EN 12208
Air permeability	Up to class 4 according to DIN EN 12207
Sound reduction	Up to Rw,P = 33 dB



TECHNICAL AREA

COLOURS & FOILS

COLOURS

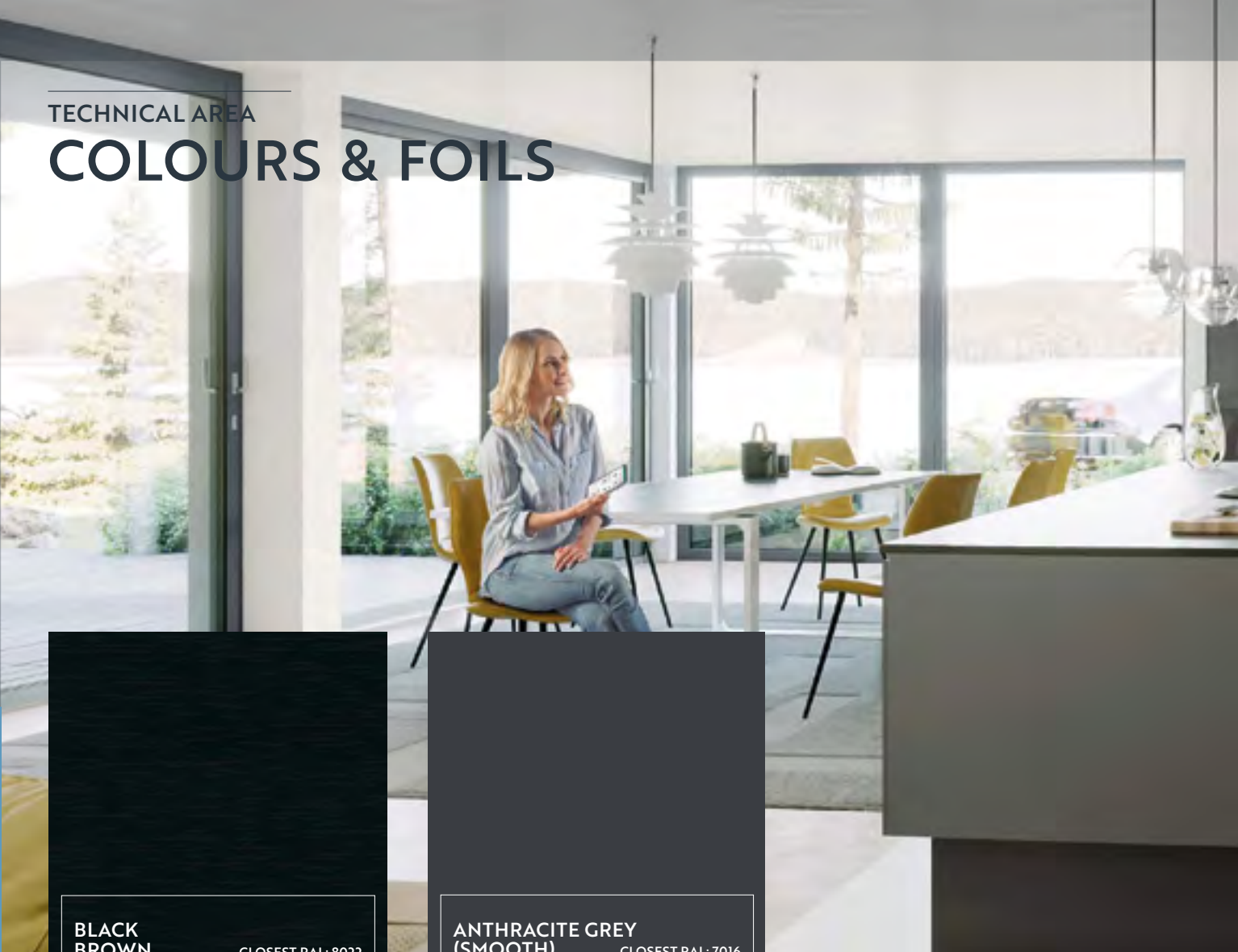

BLACK BROWN
CLOSEST RAL: 8022

ANTHRACITE GREY (SMOOTH)
CLOSEST RAL: 7016

ANTHRACITE GREY (GRAINED)
CLOSEST RAL: 7016

SLATE GREY (SMOOTH)
CLOSEST RAL: 7015

SLATE GREY (GRAINED)
CLOSEST RAL: 7015

ELEPHANT GREY
CLOSEST RAL: 7001



ELEPHANT GREY



TURNER OAK



SIMPLY WHITE CLOSEST RAL: 9010

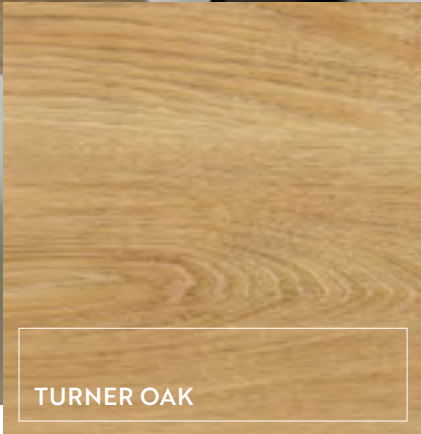

TURNER OAK



CLOTTED CREAM CLOSEST RAL: 9001

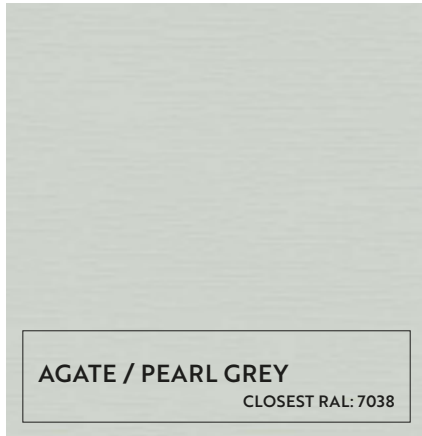

AGATE / PEARL GREY
CLOSEST RAL: 7038



IRISH OAK

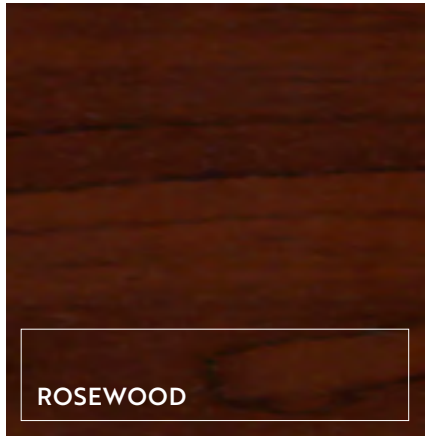

ROSEWOOD



CHARTWELL GREEN

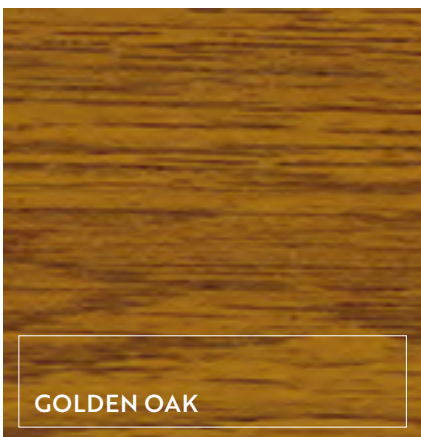

GOLDEN OAK



MAHOGANY (BEVEL ONLY)

Please note that we have tried to represent all colours as faithfully as possible but due to printing processes and the ranging differences of screens, these are to be used as guides only.

TECHNICAL AREA:

HARDWARE

COLOUR KEY:

AG	AB	Bla	Brz	Chr	FB
Anthracite Grey	Antique Black	Black	Bronze	Chrome	Forged Black

Balmoral Lever/Lever Handle	Balmoral Lever/Pad Handle	Balmoral Swan Lever Handle

AG	AB	Bla	Brz	Chr	FB	AG	AB	Bla	Brz	Chr	FB	AG	AB	Bla	Brz	Chr	FB
Gld	Gra	Pew	Sat	SS	Whi	Gld	Gra	Pew	Sat	SS	Whi	Gld	Gra	Pew	Sat	SS	Whi

Balmoral DDA Lever Handle	Balmoral Blanking plate	Heritage Lever Handle

AG	AB	Bla	Brz	Chr	FB	AG	AB	Bla	Brz	Chr	FB	AG	AB	Bla	Brz	Chr	FB
Gld	Gra	Pew	Sat	SS	Whi	Gld	Gra	Pew	Sat	SS	Whi	Gld	Gra	Pew	Sat	SS	Whi

Architectural Lever Handle	Monkey Tail Lever Handle	Noble Lever Handle

AG	AB	Bla	Brz	Chr	FB	AG	AB	Bla	Brz	Chr	FB	AG	AB	Bla	Brz	Chr	FB
Gld	Gra	Pew	Sat	SS	Whi	Gld	Gra	Pew	Sat	SS	Whi	Gld	Gra	Pew	Sat	SS	Whi

Regal Lever Handle	Straight Bar Pull Handles 400mm 800mm 1200mm 1600mm 1800mm	Swept bar handle 400mm/ 800mm

AG	AB	Bla	Brz	Chr	FB	AG	AB	Bla	Brz	Chr	FB	AG	AB	Bla	Brz	Chr	FB
Gld	Gra	Pew	Sat	SS	Whi	Gld	Gra	Pew	Sat	SS	Whi	Gld	Gra	Pew	Sat	SS	Whi

Gld	Gra	Pew	Sat	SS	Whi
Gold	Graphite	Pewter	Satin	Stainless Steel	White

Lever Rose & Escutcheon Bifold door handle	Straight Slide Patio (option 1) Patio door handle	Mini Lev, Key & Pull (option 2) Patio door handle
AG AB Bla Brz Chr FB Gld Gra Pew Sat SS Whi	AG AB Bla Brz Chr FB Gld Gra Pew Sat SS Whi	AG AB Bla Brz Chr FB Gld Gra Pew Sat SS Whi

Finger Pulls	Cylinder Escutcheons	Round Door Knob
AG AB Bla Brz Chr FB Gld Gra Pew Sat SS Whi	AG AB Bla Brz Chr FB Gld Gra Pew Sat SS Whi	AG AB Bla Brz Chr FB Gld Gra Pew Sat Sat Whi

Window Handle	Monkey Tail Handle	Pear Drop Handle
AG AB Bla Brz Chr FB Gld Gra Pew Sat SS Whi	AG AB Bla Brz Chr FB Gld Gra Pew Sat SS Whi	AG AB Bla Brz Chr FB Gld Gra Pew Sat SS Whi

Architectural Handle	Tilt & Turn handle
AG AB Bla Brz Chr FB Gld Gra Pew Sat SS Whi	AG AB Bla Brz Chr FB Gld Gra Pew Sat SS Whi



VIEW OUR OTHER PRODUCTS



Scan for all brochures

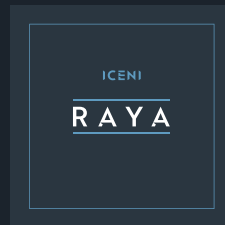

RAYA UPVC IS FABRICATED
BY ICENI FROM REHAU



Scan to check if
this brochure is
the most recent

VERSION: 1.0



• THE •
MASTER MANUFACTURERS

www.iceniwindows.co.uk